

# Q Series Cylindrical Lever Locks

## Premier Product

Arrow's Q Series Grade 1 cylindrical lever locks have been engineered for years of dependable operation. The Q combines flexible installation with the optional OverDrive™ freewheeling feature for use in the widest possible range of applications.

### Certification:



All Arrow Q Series locks are U.L. and c.U.L. listed for use on 3 hour, A label or lesser doors and are certified to conform to and exceed the requirements of ANSI/BHMA A156.2, Series 4000, Grade 1.

- Federal Specification FF-H-106C
- ANSI A117.1 Accessibility Code
- California State Reference Code for levers returning to within 1/2" (12.7mm) of door surface



### Features:

**Housing** – Cold rolled steel, with zinc dichromated finish for rust resistance. Latch retractor is precision cast steel. Extra long bearing sleeve offers added support for interlocking tubes and provides for extra lever rigidity.

Requires standard 2-1/8" (53.97mm) bore through door.

**Thru-Bolts** – Patented flexible adaptor, an eight sided nickel steel alloy mechanism allows for universal thru-bolt location according to door preparation. The flexible mounting is accomplished without manually removing screw posts from rose insert. The flexible adaptor also engages directly with springs, which will virtually eliminate lever sag.



**OverDrive™ will allow a locked lever to rotate freely without retracting the latch, improving the life and performance of Arrow locksets.**

**OverDrive™** – Freewheeling lever action occurs when latch retraction mechanism disengages from lever handle when handle is locked. Built-in stops in the rose insert prevent lever from traveling beyond approximately 57 degrees. Additional 40% spring power in rose insert on OverDrive™ side of door ensures that lever handle returns to horizontal position.

**Backset** – 2-3/4" (69.85mm) standard. 3-3/4" (95.25mm) and 5" (127mm) available.

**Latch** – Brass with 1/2" (12.7mm) throw standard. 3/4" (19.05mm) throw deadlocking firelatch is available for pairs of doors. Latch housing is steel, zinc dichromate finish for corrosion resistance. 1" (25.4mm) bore in edge of door is required.

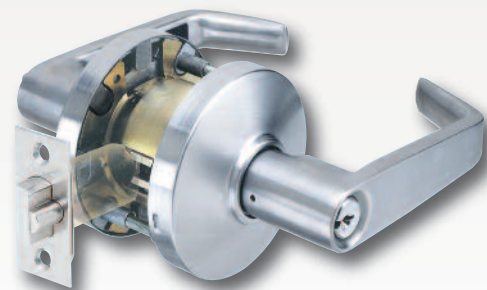

### ADA/Americans with Disabilities Act:

#### Acceptable Door Hardware: Section 4.13.9

Handles, pulls, latches and other operating devices on accessible doors shall have a shape that is easy to grasp with one hand and does not require grasping, tight pinching or twisting of the wrist to operate. Lever operated mechanisms, push-type mechanisms and "U" shaped handles are acceptable designs.



Look for the universal symbol next to Arrow products that comply with ADA accessibility requirements.

**Latch Front** – Brass, bronze or stainless steel. 2-1/4" (57.15mm) x 1-1/8" (28.57mm) beveled, 1/8" (3.175mm) in 2" (50.8mm).

**Exposed Trim** – Levers are pressure cast zinc. Streamline rose scalp of brass or bronze complements other series of lever locks.

**Rose Inserts** – Contain coil spring which is a permanent assembly within rose insert. The inside insert has graduating steps in two locations to prevent rose scalp from loosening. A "catch" on the outside insert prevents rose scalp from working itself loose during installation.

**Strikes** – Brass, bronze or stainless steel. ANSI A115.2, 4-7/8" (123.82mm) x 1-1/4" (31.75mm) curved lip strike standard. Optional 2-3/4" (69.85mm) x 1-1/8" (28.57mm) strike available. All strikes have 1-1/4" (31.75mm) lip to center dimension.

**Door Thickness** – 1-3/4" (44.45mm).

**Handing** – Non-handed. Levers operate bi-directionally.

**Finishes** – US3, US4, US10, US10B, US26, US26D. Consult factory for the availability of other non-listed finishes.

**Packaging** – 1 per box, 10 per case.

**Warranty** – Limited three year warranty.

# Q Series Cylindrical Lever Locks

## Premier Product

### Designs:

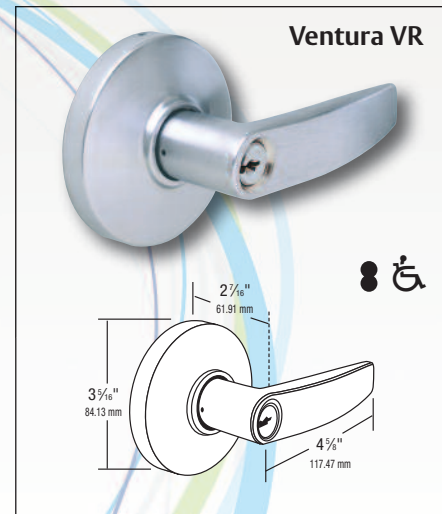
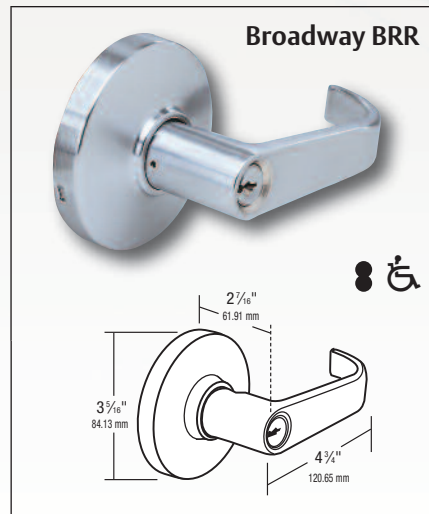
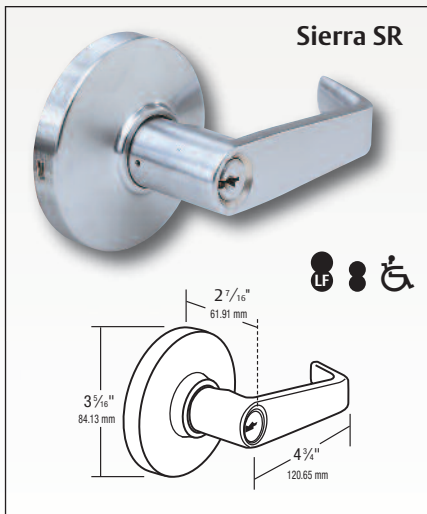

### Finishes:



BHMA	U.S. Equivalent	Arrow Equivalent	Finish
1	605 US3	03	Bright Brass
2	606 US4	04	Satin Brass
3	612 US10	10	Satin Bronze
4	613 US10B	10B	Dark Oxide Bronze, Oil Rubbed
5	625 US26	26	Bright Chromium Plated
6	626 US26D	26D	Satin Chromium Plated

### Cylinder Options:

**Conventional** – Q Series locksets are supplied standard with Arrow “A” keyway, 6 pin cylinder. As with all other lock series, various levels of masterkeying are available. Conventional cylinders are available in a variety of competitive manufacturers keyways. Supplied with two nickel silver keys.

**Interchangeable Core** – Lockset prepared to use with 6 or 7 pin interchangeable core. Supplied less core, but packed with tailpiece. Will also accept cores manufactured by Best™, Falcon™, Medeco Keymark™, ASSA™, and others. Suffix “IC” to indicate small format interchangeable core, or “LIC” (SR design only) to indicate Medeco or ASSA High Security large format interchangeable core. Temporary Arrow small format construction cores are also available.



### Interchangeable Core:

 Look for these symbols to indicate when product is available in either large or small format interchangeable core.

# Q Series Cylindrical Lever Locks

## Premier Product

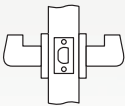
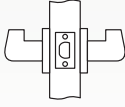
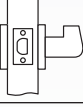
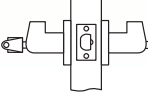
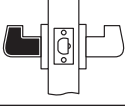
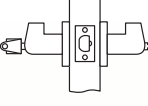
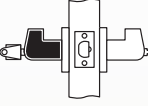
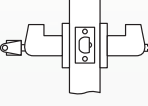
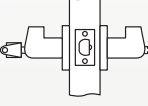

### Functions:

ARROW STANDARD	ARROW OVERDRIVE™	ANSI	FUNCTION		DESCRIPTION
Q01		F75/161N	Passage (No OverDrive™)		Latchbolt operated by lever either side.
Q02	Q72	F76/161L	Privacy		Latchbolt operated by lever either side except when inside pushbutton locks outside lever. Unlocked by turning inside lever, using emergency key outside or closing door.
Q03		F111	Communicating Passage		Dead locking latch bolt by inside lever only. Blank rose only outside.
Q06	Q76		Hospital Privacy		Latchbolt operated by lever either side except when inside pushbutton locks outside lever. Unlocked from outside by key "trapped" in outside lever. Turning inside lever or closing door will also unlock outside lever.
Q07	Q77	F89/161NX	Exit		Latchbolt operated by inside lever only. Outside lever always rigid.
Q11	Q81	F109  (F81 & F82)	Entrance/Office		Dead locking latch bolt operated by lever from either side except when outside lever is locked by pushing turn button inside. Key outside or operating inside lever releases turn button unlocking outside lever except when turn button had been rotated to keep outside lever locked. Inside turn button must be manually operated to unlock outside lever. Inside lever always operates latch bolt.
Q12	Q82	F86	Storeroom		Dead locking latch bolt operated by key in outside lever, or by operating inside lever. Outside lever is always inoperable.
Q13	Q83	F82	Exterior		Dead locking latch bolt operated by lever from either side except when outside lever is locked by push button inside. When outside lever is locked, operating key in outside lever or operating inside lever unlocks push button and retracts latchbolt. Closing door does not release push button.
Q14	Q84	F92	Service Station		Dead locking latch bolt operated by lever from either side except when outside lever is locked by push button inside. Key outside, operating inside lever or closing door releases push button unlocking outside lever except when slotted push button is in a locked position. Inside lever always operates latch bolt.
					Indicates lever rigid at all times.

# Q Series Cylindrical Lever Locks

## Premier Product

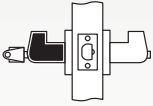
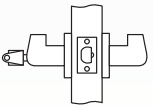
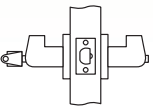
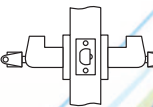
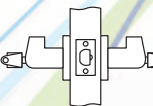
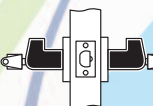
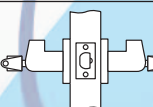
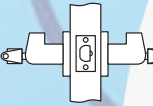
### Functions:

ARROW STANDARD	ARROW OVERDRIVE™	ANSI	FUNCTION		DESCRIPTION
Q15	Q85	F93/161H	Hotel		Latchbolt operated by inside lever at all times. Outside lever rigid at all times. Key outside will retract latch except when pushing inside button shuts out all keys except emergency key and activates visual occupancy indicator on face of cylinder. Turning inside lever or closing door releases button and retracts visual indicator. Turning inside button with spanner key will lock button in fixed position. Button then released with spanner or emergency key.
Q17	Q87	F84/161R	Classroom		Latchbolt operated by lever either side except when key outside locks outside lever. Inside lever always free. Key outside locks/unlocks outside lever only.
Q19	Q89	F90	Dormitory		Deadlocking latch bolt operated by lever from either side except when outside lever is locked by key in outside lever or by push button inside. Key in outside lever locks or unlocks outside lever. Operating inside lever releases push button placed in a locked position. Closing door releases push button. Inside lever always operates latch bolt.
Q31	Q91	F80	Communicating		Dead locking latch bolt operated by lever from either side. Turning key in either lever locks or unlocks its own lever independently. Do not use on doors in rooms that have no other entrance.
Q32	Q92	F88	Public Entrance		Dead locking latch bolt operated by lever from either side except when outside lever is locked by key from inside. When outside lever is locked, latch bolt is retracted by key in outside lever or by operating inside lever.
Q33	Q93	F87	Asylum		Dead locking latch bolt operated by key in lever, from either side. Both levers always inoperable.
Q35	Q95	F91	Exterior		Dead locking latch bolt operated by lever from either side except when both levers are locked by key from either side.
Q37	Q97	F110	Intruder Classroom		Deadlocking latch bolt operated by lever from either side. Key either inside or outside locks or unlocks outside lever. Inside lever always operates latchbolt.
					Indicates lever rigid at all times.



# Q Series Cylindrical Lever Locks

## Premier Product

### Installation:

Q Series levers employ the unique flex-adapter which allows thru-bolting installation with pre-existing holes or new installation where conditions allow thru-bolting at any location.

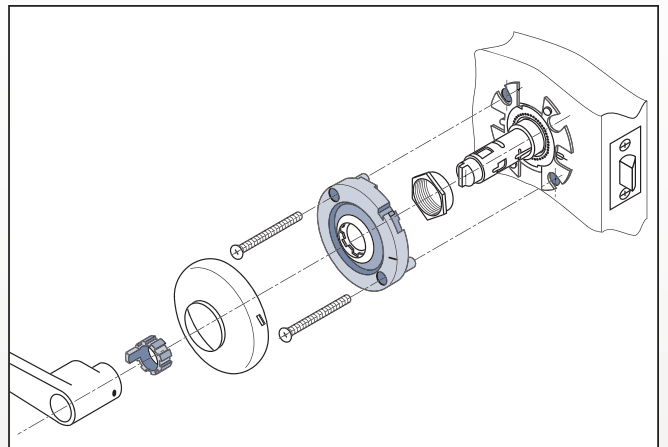
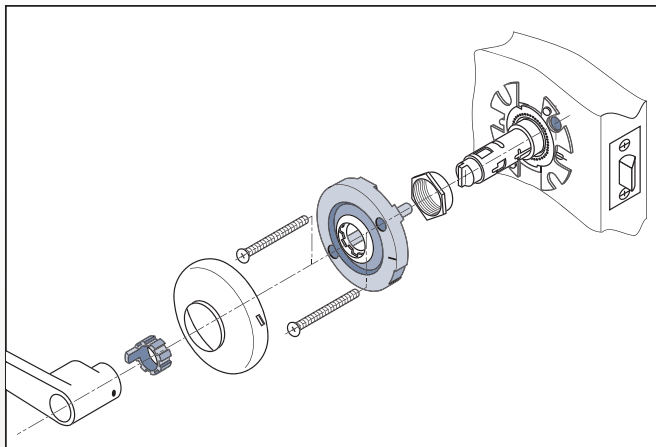
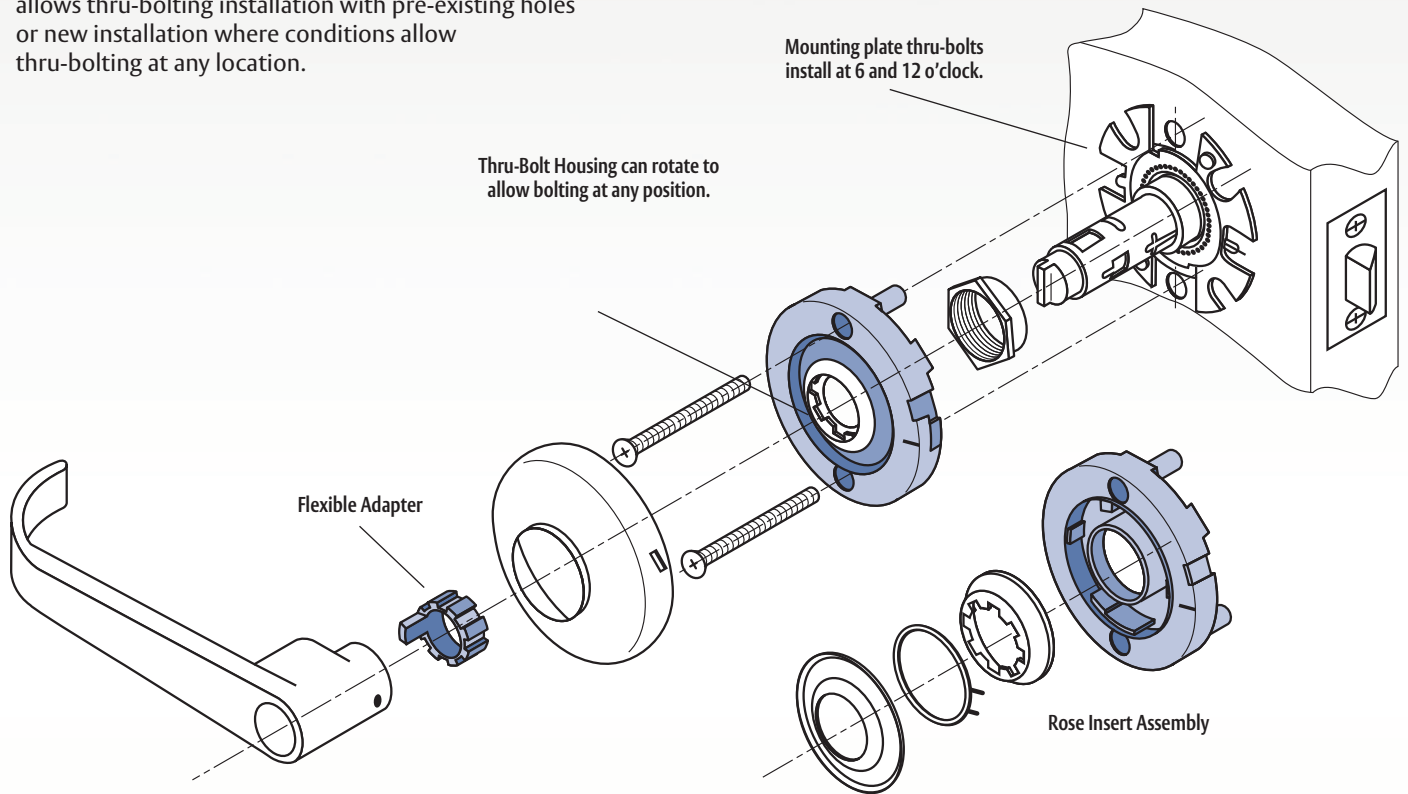

# Q Series Cylindrical Lever Locks

## Premier Product

### Electrical Lock

Arrow electro-mechanical locksets can be integrated into life safety or security systems. Fail safe or fail secure options offer flexibility for most any application while meeting U.L. requirements for fire labeled doors.

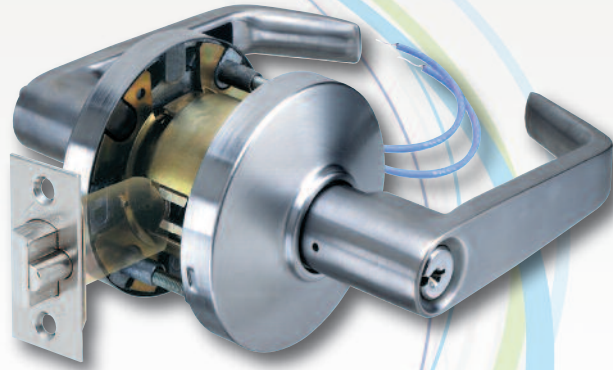

### Electrical Lock Functions:

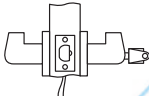
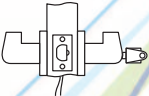
SUFFIX	VOLTAGE	CURRENT	RESISTANCE		DESCRIPTION
177 179	12V AC/DC 24V AC/DC	250mA 150mA	51 ohms 165.5 ohms		<b>FAIL SAFE:</b> Power on locks outside lever. Inside lever always free. Latch retracted by key when locked electrically.
181 183	12V AC/DC 24V AC/DC	250mA 150mA	51 ohms 165.5 ohms		<b>FAIL SECURE:</b> Power off locks outside lever. Inside lever always free. Latch retracted by key when locked electrically.





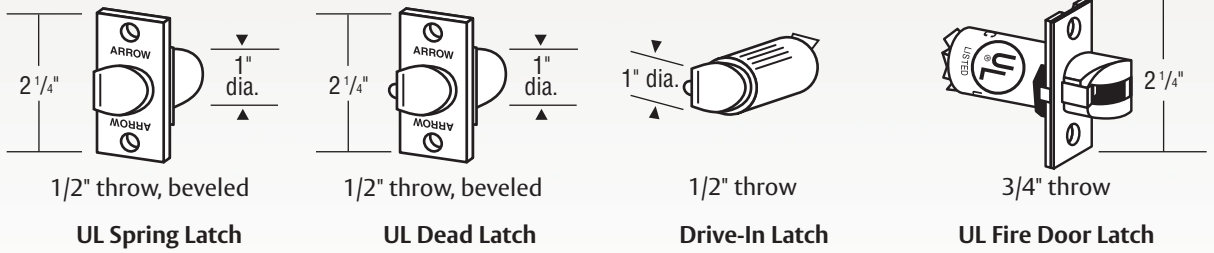

# Q Series Cylindrical Lever Locks

## Premier Product

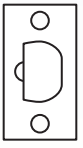
### Latches & Strikes:

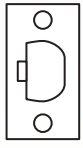
#### Latches

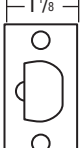
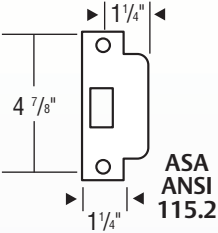
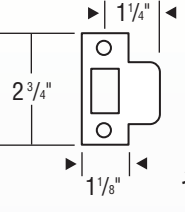
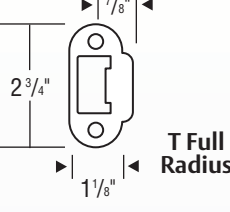

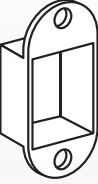
	UL Spring Latch	UL Dead Latch	Drive-In Latch	UL Fire Door Latch
<b>2-3/4" Backset</b>	 #160	 #161	 #164	 #179
<b>3-3/4" Backset</b>	 #165	 #166	N/A	N/A
<b>Strikes</b>	<b>#306</b>  ASA ANSI 115.2	<b>#320</b>  T ANSI 115.3	<b>#335</b>  T Full Radius	
<b>Boxes</b>	<b>#BX70</b> 	<b>#BX10</b> 		

### Accessories:

Extension Links #H25X5

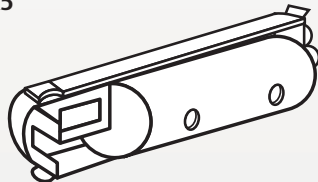

For 5" backset. Used in combination with #160 or #161 latch.

# Q Series Cylindrical Lever Locks

## Premier Product

### Suggested Specification:

All locksets shall be Q Series heavy duty cylindrical locksets as supplied by Arrow Lock company.

Locksets shall meet ANSI/BHMA requirements for Series 4000, Grade 1 and shall be U.L. and c.U.L. listed for 3 hour, A label openings. In addition, locksets shall comply with ANSI A117.1 for barrier free accessibility and the California State Reference Code (formerly Title 19, California State Fire Marshall Standard) for levers returning to within 1/2" of the door surface.

Lockset shall be non handed. A single lock chassis shall accommodate a 1-3/4" doors. Lockset through bolting shall span the ANSI standard 2-1/8" door preparation. Through bolting shall be flexible and universal, allowing for installation in a variety of locations without removal of posts. Chassis mounting screws may be accessed only with the operating key in the cylinder to remove the lever and rose.

Lockset shall have heavy strength coil springs allowing lever handle to move bi-directionally. Lockset mounting plate shall interact with protrusions on locking nut to create secure locking between the two.

Lockset shall be equipped with OverDrive™, freewheeling feature whereby the latch retraction mechanism disengages from the lever handle allowing lever to move freely when locked. A built-in stop in the rose insert shall prevent lever from traveling beyond approximately 57 degrees.

Lever trim shall consist of cast levers with wrought brass or bronze rose scalps. Levers shall be a minimum of 4-5/8" in length and where applicable shall return to within 1/2" of the door surface.

Disassembly of lockset for cylinder removal shall not be required. Cylinder shall be changed by removing the lever.

### Order Example:

**Example:** To order a Q Series classroom function lockset with a Broadway design lever, satin chrome finish, with an ASA strike and 2-3/4" backset, keyed different:

Specify:

Standard:	<u>Q</u>	<u>17</u>	<u>BRR</u>	<u>26D</u>	<u>306</u>	<u>161</u>	<u>KD</u>	<u>XXX</u>
OverDrive™:	<u>Q</u>	<u>87</u>	<u>BRR</u>	<u>26D</u>	<u>306</u>	<u>161</u>	<u>KD</u>	<u>XXX</u>
	Series	Function	Design	Finish	Strike	Latch	Keying	Options (if required)